

UNIK
KALIP ELEMANLARI / MOLD ELEMENTS

ÜRÜN KATALOĞU
PRODUCT CATALOGUE



**KALIP
ELEMANLARI**
MOLD ELEMENTS



www.unkamak.com
www.unkamak.com.tr

"Kalıp Elemanlarında Geleceği
Şekillendiriyoruz,
Güç ve Kaliteyi Hisset!"

*"Shaping the Future in Mold
Components, Feel the Power and
Quality!"*



UNIK

KALIP ELEMANLARI / MOLD ELEMENTS

UNKAMAK OTOMOTİV İLETİŞİM / CONTACT

+90 332 342 36 42



www.unkamak.com
www.unkamak.com.tr

+90 532 635 89 53



info@unkamak.com



Fevzi Çakmak Mahallesi
Özlem Cad. No:20/E 42050
Karatay / KONYA / TÜRKİYE



[unk_mold_elements](https://www.instagram.com/unk_mold_elements)



KALIP ELEMANLARI / MOLD ELEMENTS



KALIP ELEMANLARI MOLD ELEMENTS



**"Kalıp Elemanlarında
Geleceği
Şekillendiriyoruz, Güç
ve Kaliteyi Hisset!"**

*"Shaping the Future in
Mold Components, Feel the
Power and Quality!"*

www.unkamak.com
www.unkamak.com.tr

ÜNKAMAK OTOMOTİV Şirketimiz 2014 yılında kuruldu ve bir çok imalat alanında faaliyette bulundu. Bünyemizde ki üstün kalite ekipmanlarımız ve deneyimli uzman personellerimiz ile son dönemlerde UNK markamızla kalıp elamanları imalatında da başarı elde etmiş bulunmaktayız. Gün geçtikçe Türkiye pazarında tanınır ve güvenilir bir marka olmayı hedefliyoruz önceliğimiz kalıpcı ustalarımızın takdirini ve güvenini kazanmak olacak gün geçtikçe de beraber büyüyeceğiz.

Misyon: Müşterilerimize yenilikçi ve değerli ürünler sunarak, sektördeki liderliğimizi sürdürmek ve küresel pazarda rekabetçi olmak için çalışıyoruz.

Vizyon: Kalıpcılık sektöründe dünya çapında tanınan bir marka olmayı hedefliyoruz. Teknolojik yeniliklere ve kalite standartlarına yatırım yaparak, müşterilerimize en iyi hizmeti sunmayı ve sektördeki liderliğimizi güçlendirmeyi amaçlıyoruz.

ÜNKAMAK AUTOMOTIVE Our company was founded in 2014 and has operated in many manufacturing fields. With our superior quality equipment and experienced expert personnel, we have recently achieved success in the production of mold elements with our UNK brand. We aim to become a well-known and reliable brand in the Turkish market day by day. Our priority will be to gain the appreciation and trust of our mold makers and we will grow together day by day.

Mission: We aim to maintain our leadership in the industry by offering innovative and valuable products to our customers and by being competitive in the global market.

Vision: We aspire to be a globally recognized brand in the mold industry. By investing in technological innovations and quality standards, we aim to provide the best service to our customers and strengthen our leadership position in the industry.





UNK 01

Şapkalı Kolon
Guide Pillar

06



UNK 10

Yağ Kanalsız
Şapkalı Kolon
Guide Pillar

09



UNK 02

Şapkalı
Kademeli Kolon
Guide Pillar

12



UNK 03

Kuyruklu Şapkalı
Kademeli Kolon
Tailed Guide Pillar

30



UNK 21H

Kuyruklu
Şapkalı Burç
Tailed Guide
Bush

44



UNK 20

Şapkalı Burç
Guide Bush

47



UNK 40H

Tespit Burcu
Centring Slaves

48



UNK 50

Konik Kitleme
Locating Unit

50



UNK 22

Ortadan
Flanşlı Burç
Middle Flanged
Bush

51



UNK 00

Ortadan
Şapkalı Kolon
Guide Pillar

52



UNK 09

Düz Kolon
Guide Pillar

56



UNK 23

Ortadan
Şapkalı Burç
Guide Bush

59



UNK 4-20

Düz
Tespit Pimi
Detection Pin

60



UNK 5-20

Çektirmeli
Tespit Pimi
Puller Pins

61



UNK 24

Üstten
Şapkalı Burç
Guide Bush

62



UNK ER16

Kılavuz
Çekme Aparatı
Tapping Apparatus

63

UNK 01

Şapkalı Kolon

Guide Pillar

Malzeme / Material
1.7131 (16MnCr5)

Sertlik / Hardness
61 - 63 HRC

Isıl İşlem / Heat Treatment

Sementasyon / Case Hardened

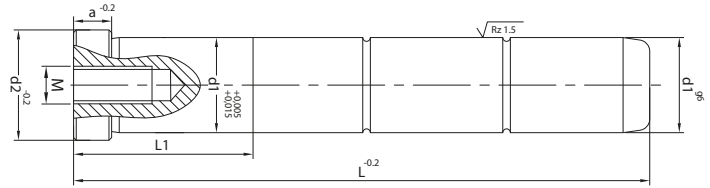
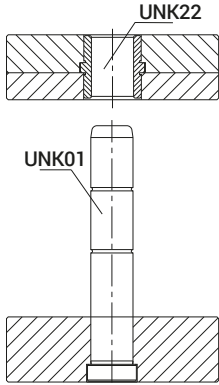

Sipariş Kodu / Order Code	d1	L	L1	d2	a	M
UNK 01-1260	12	60	22	16	10	-
80		80	27			
100		100	36			
120		120				
140		140				
160		160				
UNK 01-1460	14	60	22	18	10	-
80		80	27			
100		100	36			
120		120				
140		140				
160		160				
180	180	46				
UNK 01-1660	16	60	22	20	10	6
80		80	27			
100		100	36			
120		120				
140		140				
160		160				
180		180	46			
200		200	56			
220		220				
250		250	66			

UNK 01

Şapkalı Kolon

Guide Pillar

Malzeme / Material
1.7131 (16MnCr5)

Sertlik / Hardness
61 - 63 HRC

Isıl İşlem / Heat Treatment

Sementasyon / Case Hardened

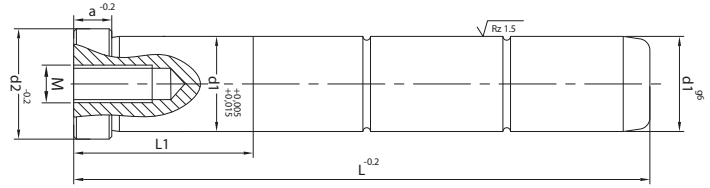
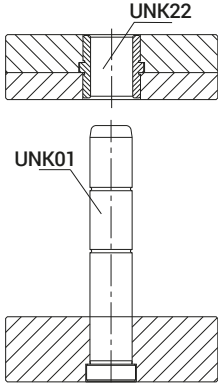

Sipariş Kodu / Order Code	d1	L	L1	d2	a	M
UNK 01-25100	25	100	27	29	10	8
120		120	36			
140		140				
160		160				
180		180	46			
200		200	56			
220		220				
250		250	66			
300		300	76			
UNK 01-30100		30	100			
120	120		36			
140	140					
160	160					
180	180		46			
200	200		56			
220	220					
250	250		66			
300	300		76			
UNK 01-40160	40		160	36	48	15
180		180	46			
200		200	56			
220		220				
250		250	66			
280		280				
300		300	76			
315		320				
360		360				

UNK 10

Yağ Kanalsız Şapkalı Kolon Guide Pillar

Malzeme / Material
1.7131 (16MnCr5)

Sertlik / Hardness
61 - 63 HRC

Isıl İşlem / Heat Treatment

Sementasyon / Case Hardened

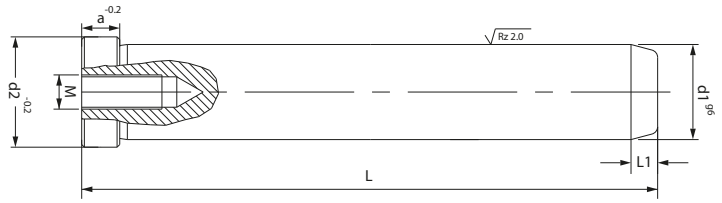
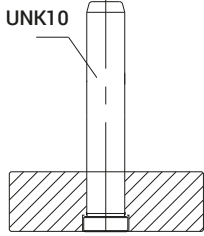
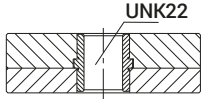

Sipariş Kodu / Order Code	d1	L	L1	d2	a	M
UNK 10-1060	10	60	4	12	3	6
80		80				
100		100				
120		120				
140		140				
UNK 10-1260	12	60	7	16	6	6
80		80				
100		100				
120		120				
140		140				
160	160					
UNK 10-1460	14	60	7	18	8	6
80		80				
100		100				
120		120				
140		140				
160	160					
180	180					
UNK 10-1660	16	60	7	20	8	8
80		80				
100		100				
120		120				
140		140				
160	160					
180	180					
200	200					

UNK 10

Yağ Kanalsız Şapkalı Kolon Guide Pillar

Malzeme / Material
1.7131 (16MnCr5)

Sertlik / Hardness
61 - 63 HRC

Isıl İşlem / Heat Treatment

Sementasyon / Case Hardened

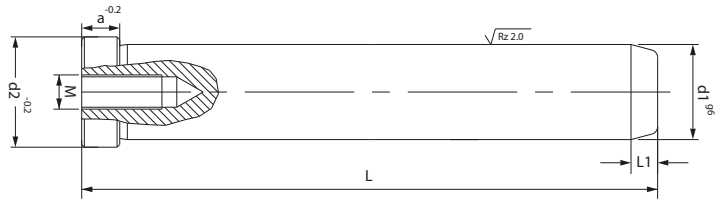
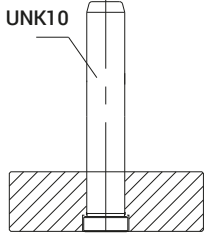
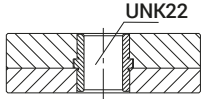

Sipariş Kodu / Order Code	d1	L	L1	d2	a	M
UNK 10-1860	18	60	7	22	8	10
80						
100						
120						
140						
160						
180						
200						
240						
UNK 10-2060	20	60	7	24	8	10
80						
100						
120						
140						
160						
180						
200						
240						
300						
UNK 10-2280	22	80	7	26	15	10
100						
120						
140						
160						
180						
200						
220						
240						
300						

UNK 10

Yağ Kanalsız Şapkalı Kolon Guide Pillar

Malzeme / Material
1.7131 (16MnCr5)

Sertlik / Hardness
61 - 63 HRC

Isıl İşlem / Heat Treatment

Sementasyon / Case Hardened

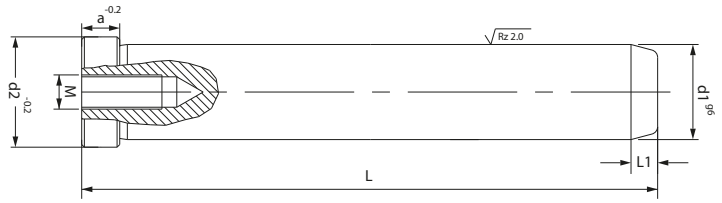
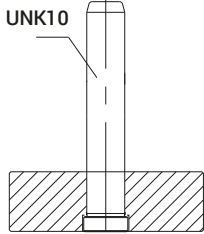
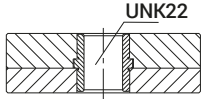

Sipariş Kodu / Order Code	d1	L	L1	d2	a	M
UNK 10-2480	24	80	7	28	15	12
100		100				
120		120				
140		140				
160		160				
180		180				
200		200				
220		220				
240		240				
300		300				
UNK 10-30100		30				
120	120					
140	140					
160	160					
180	180					
200	200					
220	220					
240	240					
300	300					
360	360					
UNK 10-40160	40	160	10	48	15	16
200		200				
240		240				
300		300				
360		360				

UNK 02

**Şapkalı
Kademeli Kolon**
Guide Pillar

Malzeme / Material 1.7131 (16MnCr5)

Sertlik / Hardness 61 - 63 HRC

Isıl İşlem / Heat Treatment

Sementasyon / Case Hardened

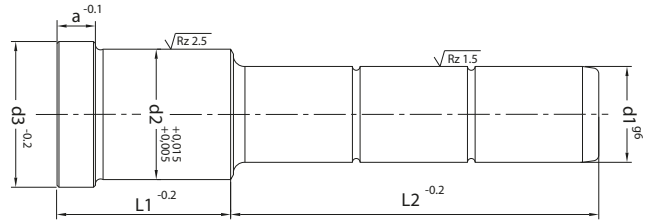
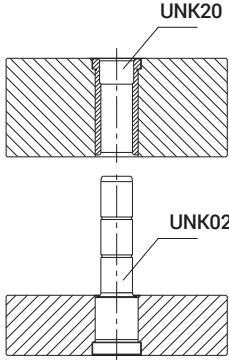

Sipariş Kodu / Order Code	d1	L1	L2	d2	d3	a
UNK 02-122626			26			
36	12	26	36	16	19	4
46			46			
56			56			
66			66			
UNK 02-123626			26			
36	12	36	36	16	19	4
46			46			
56			56			
66			66			
UNK 02-124626			26			
36	12	46	36	16	19	4
46			46			
56			56			
66			66			
66			66			
UNK 02-142626			26			
36	14	26	36	20	25	6
46			46			
56			56			
66			66			
66			66			
76			76			
UNK 02-143626			26			
36	14	36	36	20	25	6
46			46			
56			56			
66			66			
66			66			
86			86			

UNK 02

**Şapkalı
Kademeli Kolon**
Guide Pillar

Malzeme / Material
1.7131 (16MnCr5)
Sertlik / Hardness
61 - 63 HRC
Isıl İşlem / Heat Treatment
Sementasyon / Case Hardened

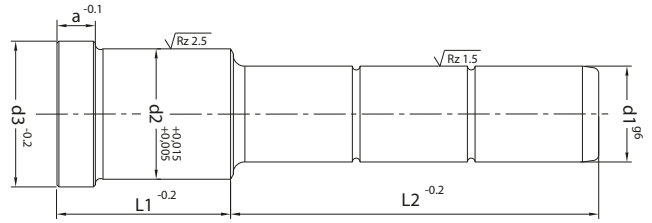
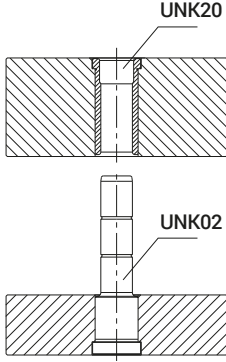

Sipariş Kodu / Order Code	d1	L1	L2	d2	d3	a
UNK 02-144626	14	46	26	20	25	6
36			36			
46			46			
56			56			
76			76			
96			96			
UNK 02-145626	14	56	26	20	25	6
36			36			
46			46			
66			66			
86			86			
106			106			
UNK 02-162626	16	26	26	24	28	6
36			36			
46			46			
56			56			
76			76			
96			96			
UNK 02-163626	16	36	26	24	28	6
36			36			
46			46			
56			56			
66			66			
86			86			
106	106					

UNK 02

Şapkalı Kademeli Kolon Guide Pillar

Malzeme / Material
1.7131 (16MnCr5)

Sertlik / Hardness
61 - 63 HRC

Isıl İşlem / Heat Treatment

Sementasyon / Case Hardened

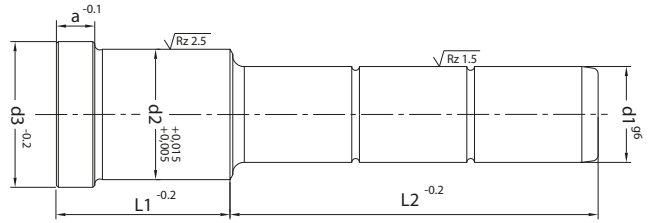
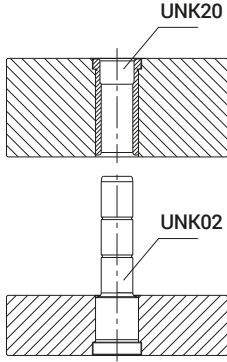

Sipariş Kodu / Order Code	d1	L1	L2	d2	d3	a
UNK 02-164626	16	46	26	24	28	6
36			36			
46			46			
56			56			
66			66			
76			76			
96			96			
116			116			
UNK 02-165626	16	56	26	24	28	6
36			36			
46			46			
56			56			
66			66			
76			76			
96			96			
116			116			
UNK 02-166626	16	66	26	24	28	6
36			36			
46			46			
56			56			
66			66			
76			76			
86			86			
106			106			
116	116					

UNK 02

**Şapkalı
Kademeli Kolon**
Guide Pillar

Malzeme / Material
1.7131 (16MnCr5)
Sertlik / Hardness
61 - 63 HRC
Isıl İşlem / Heat Treatment
Sementasyon / Case Hardened

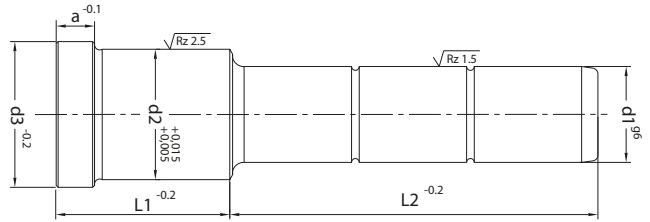
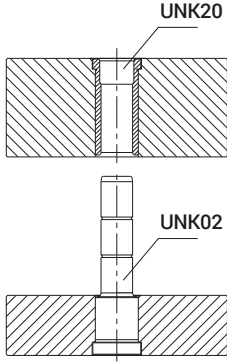

Sipariş Kodu / Order Code	d1	L1	L2	d2	d3	a
UNK 02-167626	16	76	26	24	28	6
36			36			
46			46			
56			56			
66			66			
76			76			
96			96			
116			116			
UNK 02-168626	16	86	26	24	28	6
36			36			
46			46			
56			56			
66			66			
76			76			
96			96			
116			116			
UNK 02-182626	18	26	26	26	31	6
36			36			
46			46			
56			56			
66			66			
86			86			

UNK 02

**Şapkalı
Kademeli Kolon**
Guide Pillar

Malzeme / Material
1.7131 (16MnCr5)
Sertlik / Hardness
61 - 63 HRC
Isıl İşlem / Heat Treatment
Sementasyon / Case Hardened

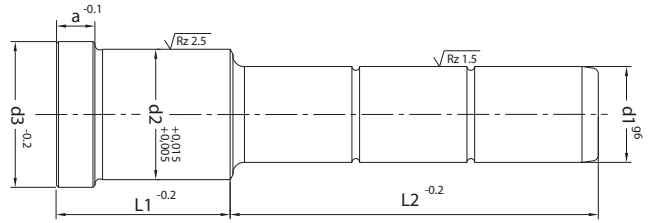
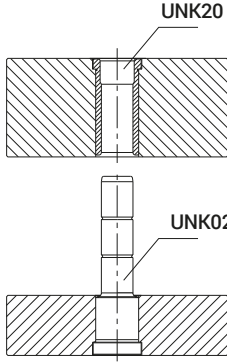

Sipariş Kodu / Order Code	d1	L1	L2	d2	d3	a
UNK 02-183626	18	36	26	26	31	6
36			36			
46			46			
56			56			
66			66			
86			86			
106			106			
UNK 02-184626	18	46	26	26	31	6
36			36			
46			46			
56			56			
66			66			
86			86			
106			106			
126	126					
UNK 02-185626	18	56	26	26	31	6
36			36			
46			46			
56			56			
66			66			
86			86			
106			106			
126	126					

UNK 02

Şapkalı Kademeli Kolon Guide Pillar

Malzeme / Material
1.7131 (16MnCr5)

Sertlik / Hardness
61 - 63 HRC

Isıl İşlem / Heat Treatment

Sementasyon / Case Hardened

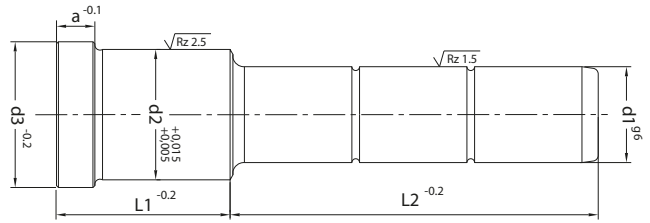
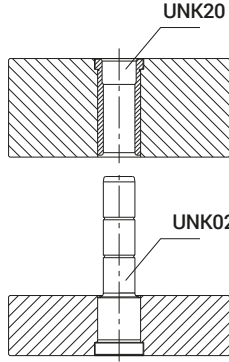

Sipariş Kodu / Order Code	d1	L1	L2	d2	d3	a
UNK 02-186626	18	66	26	26	31	6
36			36			
56			56			
76			76			
96			96			
116			116			
UNK 02-187626	18	76	26	26	31	6
46			46			
66			66			
86			86			
106			106			
126			126			
UNK 02-188626	18	86	26	26	31	6
46			46			
66			66			
86			86			
106			106			
126			126			
UNK 02-202626	20	26	26	28	32	6
36			36			
46			46			
56			56			
66			66			
86			86			

UNK 02

Şapkalı Kademeli Kolon Guide Pillar

Malzeme / Material
1.7131 (16MnCr5)
Sertlik / Hardness
61 - 63 HRC
Isıl İşlem / Heat Treatment
Sementasyon / Case Hardened

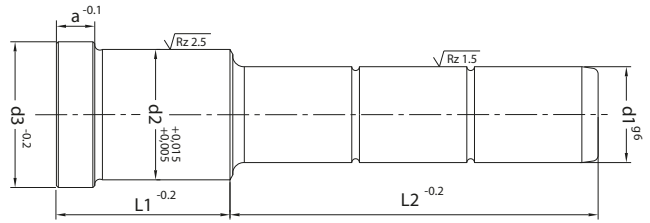
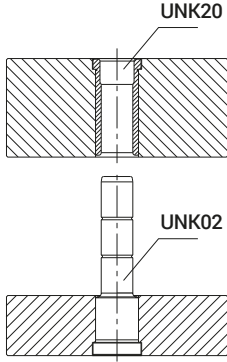

Sipariş Kodu / Order Code	d1	L1	L2	d2	d3	a
UNK 02-203626	20	36	26	28	32	6
36			36			
46			46			
56			56			
66			66			
76			76			
96			96			
UNK 02-204626	20	46	26	28	32	6
36			36			
46			46			
56			56			
66			66			
76			76			
86			86			
106	106					
UNK 02-205626	20	56	26	28	32	6
36			36			
46			46			
56			56			
66			66			
76			76			
96			96			
116	116					

UNK 02

**Şapkalı
Kademeli Kolon**
Guide Pillar

Malzeme / Material
1.7131 (16MnCr5)
Sertlik / Hardness
61 - 63 HRC
Isıl İşlem / Heat Treatment
Sementasyon / Case Hardened

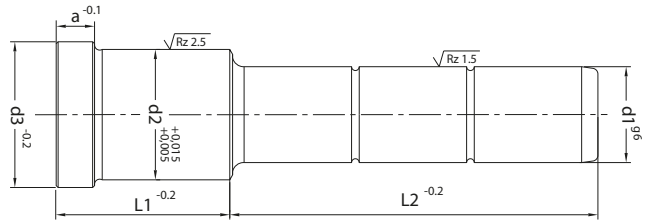
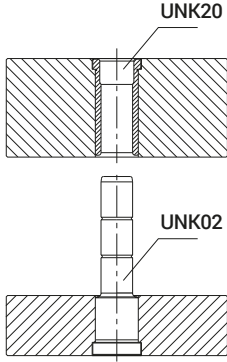

Sipariş Kodu / Order Code	d1	L1	L2	d2	d3	a					
UNK 02-206626	20	66	26	28	32	6					
36			36								
46			46								
56			56								
66			66								
76			76								
96			96								
116			116								
UNK 02-207626			20				76	26	28	32	6
36								36			
46	46										
56	56										
66	66										
76	76										
86	86										
106	106										
126	126										
UNK 02-208626	20	86		26	28	32		6			
36			36								
46			46								
56			56								
66			66								
76			76								
86			86								
106			106								
126			126								

UNK 02

**Şapkalı
Kademeli Kolon**
Guide Pillar

Malzeme / Material
1.7131 (16MnCr5)
Sertlik / Hardness
61 - 63 HRC
Isıl İşlem / Heat Treatment
Sementasyon / Case Hardened

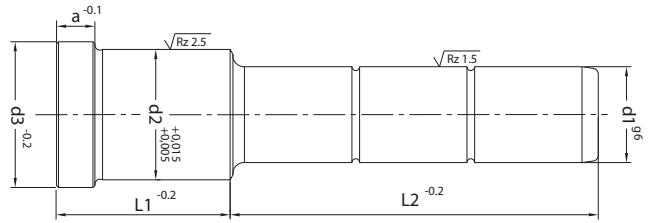
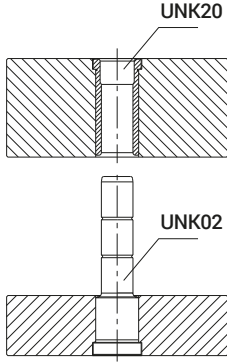

Sipariş Kodu / Order Code	d1	L1	L2	d2	d3	a
UNK 02-209626	20	96	26	28	32	6
36			36			
46			46			
56			56			
66			66			
76			76			
86			86			
106			106			
UNK 02-252626	25	26	26	34	38	8
36			36			
46			46			
56			56			
66			66			
76			76			
96	96					
UNK 02-253626	25	36	26	34	38	8
36			36			
46			46			
56			56			
66			66			
76			76			
86			86			
106	106					

UNK 02

Şapkalı Kademeli Kolon Guide Pillar

Malzeme / Material
1.7131 (16MnCr5)
Sertlik / Hardness
61 - 63 HRC
Isıl İşlem / Heat Treatment
Sementasyon / Case Hardened

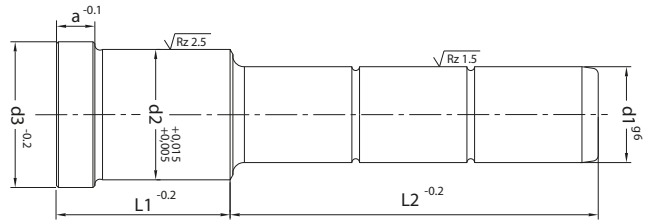
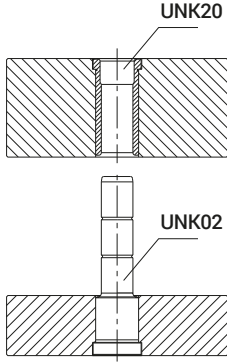

Sipariş Kodu / Order Code	d1	L1	L2	d2	d3	a
UNK 02-254626	25	46	26	34	38	8
36			36			
46			46			
56			56			
66			66			
76			76			
96			96			
116			116			
UNK 02-255626	25	56	26	34	38	8
36			36			
46			46			
56			56			
66			66			
76			76			
96			96			
116			116			
UNK 02-256626	25	66	26	34	38	8
36			36			
46			46			
56			56			
66			66			
76			76			
86			86			
106			106			
126	126					

UNK 02

**Şapkalı
Kademeli Kolon**
Guide Pillar

Malzeme / Material
1.7131 (16MnCr5)
Sertlik / Hardness
61 - 63 HRC
Isıl İşlem / Heat Treatment
Sementasyon / Case Hardened

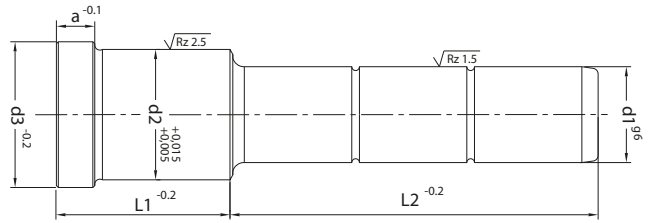
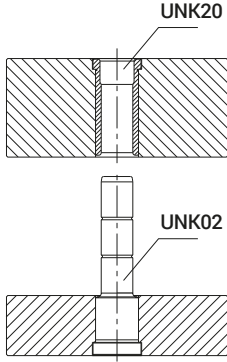

Sipariş Kodu / Order Code	d1	L1	L2	d2	d3	a
UNK 02-257626	25	76	26	34	38	8
36			36			
46			46			
56			56			
66			66			
76			76			
86			86			
106			106			
126			126			
UNK 02-258636			25			
46	46					
56	56					
66	66					
76	76					
86	86					
96	96					
116	116					
136	136					
UNK 02-259636	25	96	36	34	38	8
46			46			
56			56			
66			66			
76			76			
86			86			
96			96			
116			116			
136			136			

UNK 02

Şapkalı Kademeli Kolon Guide Pillar

Malzeme / Material
1.7131 (16MnCr5)

Sertlik / Hardness
61 - 63 HRC

Isıl İşlem / Heat Treatment

Sementasyon / Case Hardened

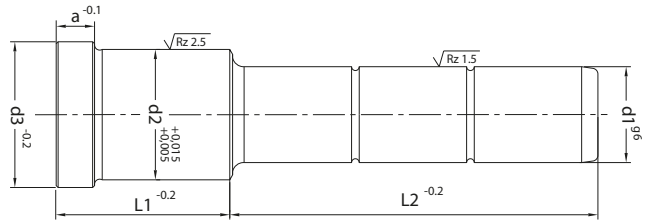
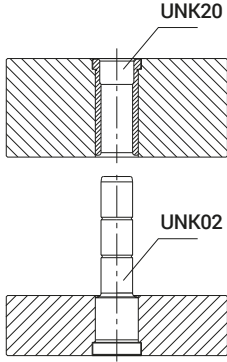

Sipariş Kodu / Order Code	d1	L1	L2	d2	d3	a
UNK 02-2510646	25	106	46	34	38	8
56			56			
66			66			
76			76			
86			86			
96			96			
116			116			
136			136			
UNK 02-303636	30	36	36	39	43	10
46			46			
56			56			
66			66			
86			86			
106			106			
UNK 02-304636	30	46	36	39	43	10
46			46			
56			56			
66			66			
76			76			
96			96			
116	116					

UNK 02

**Şapkalı
Kademeli Kolon**
Guide Pillar

Malzeme / Material
1.7131 (16MnCr5)
Sertlik / Hardness
61 - 63 HRC
Isıl İşlem / Heat Treatment
Sementasyon / Case Hardened

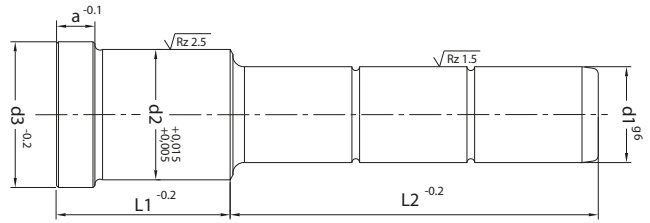
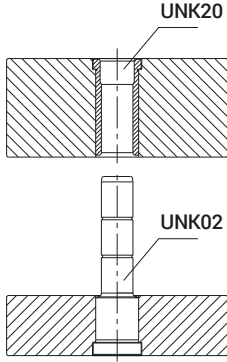

Sipariş Kodu / Order Code	d1	L1	L2	d2	d3	a
UNK 02-305636	30	56	36	39	43	10
46			46			
56			56			
66			66			
76			76			
86			86			
106			106			
126			126			
UNK 02-306636	30	66	36	39	43	10
46			46			
56			56			
66			66			
76			76			
86			86			
96			96			
116			116			
136	136					
UNK 02-307636	30	76	36	39	43	10
46			46			
56			56			
76			76			
96			96			
116			116			
136	136					

UNK 02

**Şapkalı
Kademeli Kolon**
Guide Pillar

Malzeme / Material
1.7131 (16MnCr5)
Sertlik / Hardness
61 - 63 HRC
Isıl İşlem / Heat Treatment
Sementasyon / Case Hardened

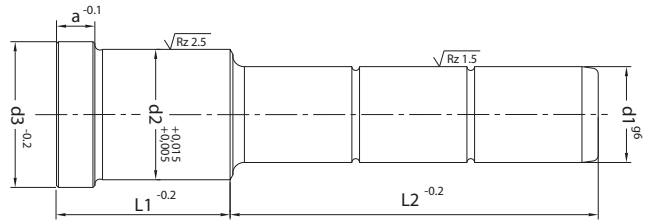
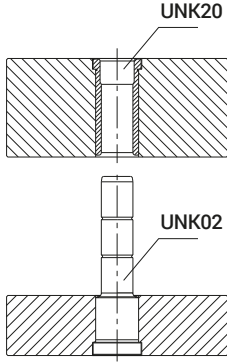

Sipariş Kodu / Order Code	d1	L1	L2	d2	d3	a
UNK 02-308636	30	86	36	39	43	10
46			46			
66			66			
86			86			
106			106			
126			126			
146			146			
UNK 02-309646	30	96	46	39	43	10
66			66			
86			86			
106			106			
126			126			
146			146			
UNK 02-3010656	30	106	56	39	43	10
76			76			
96			96			
116			116			
136			136			
UNK 02-3011656	30	116	56	39	43	10
76			76			
96			96			
116			116			
136			136			

UNK 02

**Şapkalı
Kademeli Kolon**
Guide Pillar

Malzeme / Material
1.7131 (16MnCr5)
Sertlik / Hardness
61 - 63 HRC
Isıl İşlem / Heat Treatment
Sementasyon / Case Hardened

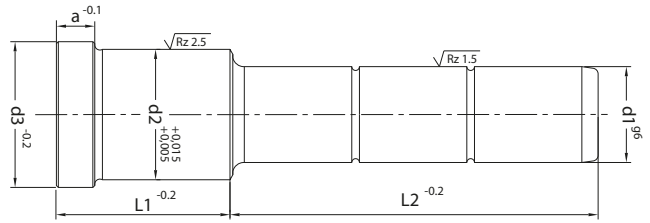
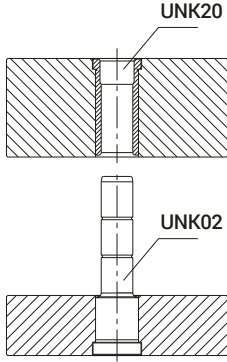

Sipariş Kodu / Order Code	d1		L2	d2	d3	a
UNK 02-405656	40	56	56	54	58	10
86			86			
106			106			
126			126			
156			156			
186			186			
UNK 02-406666	40	66	66	54	58	10
96			96			
116			116			
136			136			
166			166			
196			196			
UNK 02-407676	40	76	76	54	58	10
106			106			
126			126			
146			146			
166			166			
196			196			
216	216					
UNK 02-408686	40	86	86	54	58	10
126			126			
146			146			
176			176			
206			206			
226			226			

UNK 02

**Şapkalı
Kademeli Kolon**
Guide Pillar

Malzeme / Material
1.7131 (16MnCr5)
Sertlik / Hardness
61 - 63 HRC
Isıl İşlem / Heat Treatment
Sementasyon / Case Hardened

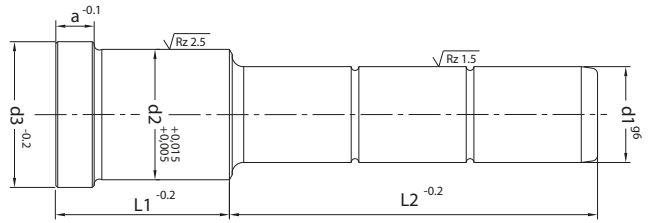
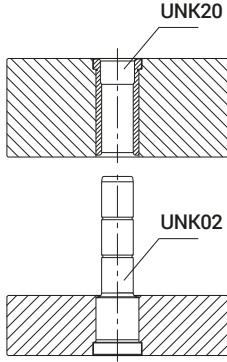

Sipariş Kodu / Order Code	d1	L2	d2	d3	a
UNK 02-409696	40	96	54	58	10
136		136			
156		156			
186		186			
216		216			
236		236			
UNK 02-40106106	40	106	54	58	10
126		126			
156		156			
186		186			
226		226			
246		246			
UNK 02-40116116	40	116	54	58	10
136		136			
166		166			
196		196			
236		236			
256		256			
UNK 02-40126126	40	126	54	58	10
166		166			
196		196			
236		236			
266		266			
UNK 02-40136136		40			
196	196				
226	226				
266	266				

UNK 02

Şapkalı Burç

Guide Bush

Malzeme / Material
1.7131 (16MnCr5)

Sertlik / Hardness
61 - 63 HRC

Isıl İşlem / Heat Treatment

Sementasyon / Case Hardened

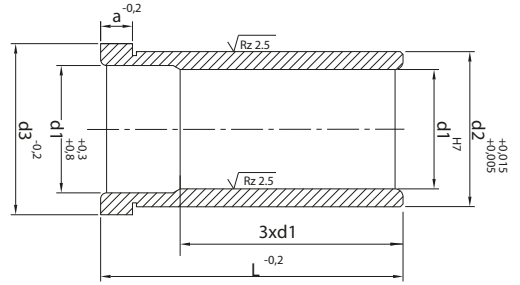
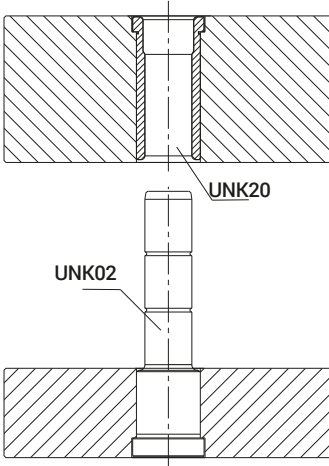

Sipariş Kodu / Order Code	d1	L	d2	d3	a
UNK 20-1226	12	26	16	19	4
36		36			
46		46			
56		56			
66		66			
UNK 20-1426	14	26	20	25	6
36		36			
46		46			
56		56			
66		66			
76	76				
86	86				
UNK 20-1626	16	26	24	28	6
36		36			
46		46			
56		56			
66		66			
76	76				
86	86				

UNK 02

Şapkalı Burç

Guide Bush

Malzeme / Material
1.7131 (16MnCr5)

Sertlik / Hardness
61 - 63 HRC

Isıl İşlem / Heat Treatment

Sementasyon / Case Hardened

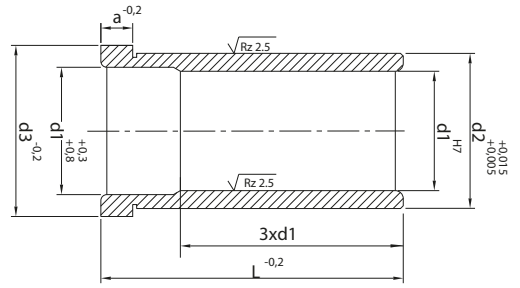
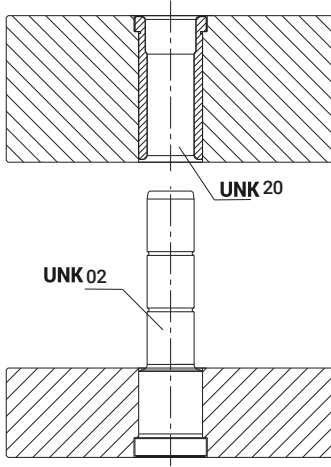

Sipariş Kodu / Order Code	d1	L	d2	d3	a
UNK 20-1826	18	26	26	31	6
36		36			
46		46			
56		56			
66		66			
76		76			
86		86			
UNK 20-2026	20	26	28	32	6
36		36			
46		46			
56		56			
66		66			
76		76			
86		86			
96	96				
UNK 20-2526	25	26	34	38	8
36		36			
46		46			
56		56			
66		66			
76		76			
86		86			
96	96				
106	106				

UNK 03

Kuyruklu Şapkalı Kademeli Kolon Tailed Guide Pillar

Malzeme / Material
1.7131 (16MnCr5)

Sertlik / Hardness
61 - 63 HRC

Isıl İşlem / Heat Treatment

Sementasyon / Case Hardened

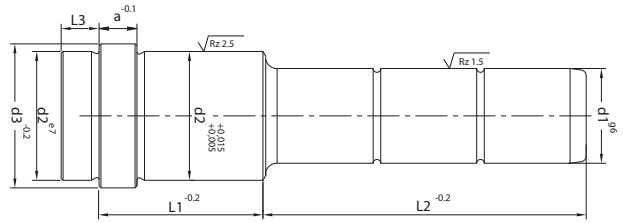
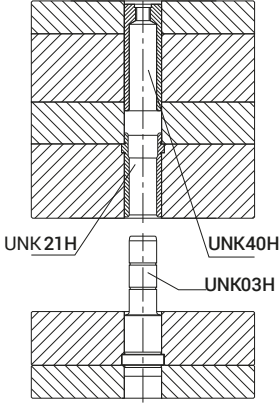

Sip. Kodu / Or. Code	d1	Sip. Kodu / Or. Code	d1	L1	L2	d2	d3	a	L3
UNK03H-141735	14	03H-151735	15	17	35	20	25	6	9
55		55							
75		75							
95		95							
UNK03H-142230	14	03H-152230	15	22	30	20	25	6	9
50		50							
70		70							
90		90							
110		110							
125		125							
150	150								
UNK03H-142730	14	03H-152730	15	27	30	20	25	6	9
45		45							
65		65							
85		85							
105		105							
125		125							
145		145							
165	165								
UNK03H-143635	14	03H-153635	15	36	35	20	25	6	9
55		55							
75		75							
95		95							
115		115							
125		125							
145		145							
155		155							

UNK 03

Kuyruklu Şapkalı Kademeli Kolon Tailed Guide Pillar

Malzeme / Material
1.7131 (16MnCr5)

Sertlik / Hardness
61 - 63 HRC

Isıl İşlem / Heat Treatment

Sementasyon / Case Hardened

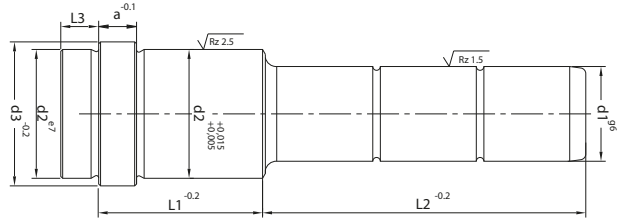
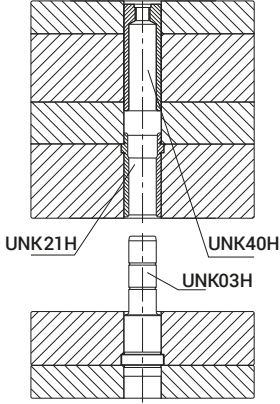

Sip. Kodu / Or. Code	d1	Sip. Kodu / Or. Code	d1	L1	L2	d2	d3	a	L3
UNK 03H-144635	14	03H-154635	15	46	35	20	25	6	9
45		45							
65		65							
85		85							
105		105							
125		125							
145	145								
UNK 03H-145635	14	03H-155635	15	56	35	20	25	6	9
55		55							
75		75							
95		95							
135	135								
UNK 03H-146655	14	03H-156655	15	66	55	20	25	6	9
65		65							
85		85							
95		95							
105		105							
125	125								
UNK 03H-147635	14	03H-157635	15	76	35	20	25	6	9
55		55							
75		75							
95		95							
125	125								

UNK 03

Kuyruklu Şapkalı Kademeli Kolon Tailed Guide Pillar

Malzeme / Material
1.7131 (16MnCr5)

Sertlik / Hardness
61 - 63 HRC

Isıl İşlem / Heat Treatment

Sementasyon / Case Hardened

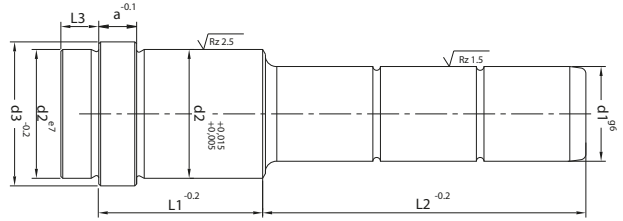
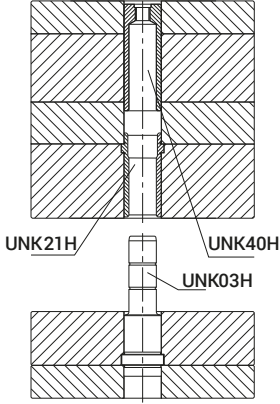

Sip. Kodu / Or. Code	d1	Sip. Kodu / Or. Code	d1	L1	L2	d2	d3	a	L3
UNK 03H-148655	14	03H-158655	15	86	55	20	25	6	9
75		75			75				
95		95			95				
UNK 03H-149655	14	03H-159655	15	96	55	20	25	6	9
75		75			75				
95		95			95				
UNK 03H-1411675	14	03H-1511675	15	116	75	20	25	6	9
UNK 03H-181735	18	03H-201735	20	17	35	26	31	6	9
55		55			55				
75		75			75				
		120			120				
UNK 03H-182235	18	03H-202235	20	22	35	26	31	6	9
45		45			45				
65		65			65				
85		85			85				
95		95			95				
115	115	115							
UNK 03H-182735	18	03H-202735	20	27	35	26	31	6	9
45		45			45				
65		65			65				
85		85			85				
105		105			105				
125		125			125				
165		165			165				
225		225			225				
245	245	245							

UNK 03

Kuyruklu Şapkalı Kademeli Kolon Tailed Guide Pillar

Malzeme / Material
1.7131 (16MnCr5)

Sertlik / Hardness
61 - 63 HRC

Isıl İşlem / Heat Treatment

Sementasyon / Case Hardened

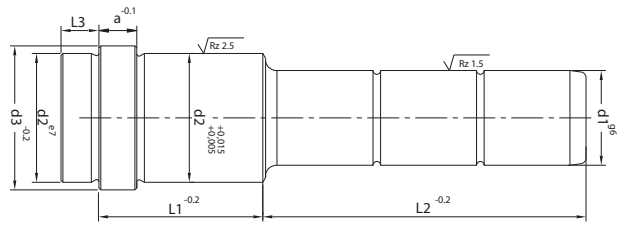
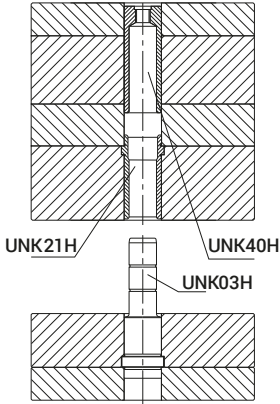

Sip. Kodu / Or. Code	d1	Sip. Kodu / Or. Code	d1	L1	L2	d2	d3	a	L3
03H-183635	18	03H-203635	20	36	35	26	31	6	9
55		55							
75		75							
95		95							
115		115							
135		135							
165		165							
225		225							
255	255								
03H-184635	18	03H-204635	20	46	35	26	31	6	9
45		45							
65		65							
85		85							
105		105							
135		135							
165		165							
245	245								
03H-185635	18	03H-205635	20	56	35	26	31	6	9
55		55							
75		75							
95		95							
115		115							
135		135							
155	155								

UNK 03

Kuyruklu Şapkalı Kademeli Kolon Tailed Guide Pillar

Malzeme / Material
1.7131 (16MnCr5)

Sertlik / Hardness
61 - 63 HRC

Isıl İşlem / Heat Treatment

Sementasyon / Case Hardened

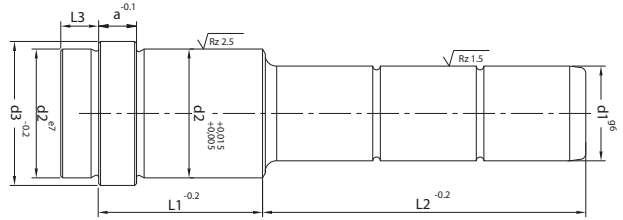
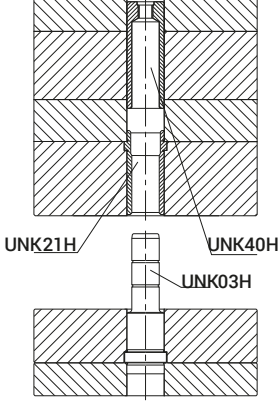

Sip. Kodu / Or. Code	d1	Sip. Kodu / Or. Code	d1	L1	L2	d2	d3	a	L3
UNK03H-186635	18	03H-206635	20	66	35	26	31	6	9
55		55							
75		75							
95		95							
115		115							
135		135							
145		145							
UNK03H-187635	18	03H-207635	20	76	35	26	31	6	9
55		55							
75		75							
95		95							
135		135							
UNK03H-188655	18	03H-208655	20	86	55	26	31	6	9
75		75							
95		95							
135		135							
UNK03H-189655	18	03H-209655	20	96	55	26	31	6	9
75		75							
95		95							
UNK03H-1811675	18	03H-2011675	20	116	75	26	31	6	9
115		115							
03H-18136135	18	03H-20136135	20	136	35	26	31	6	9

UNK 03

Kuyruklu Şapkalı Kademeli Kolon Tailed Guide Pillar

Malzeme / Material
1.7131 (16MnCr5)

Sertlik / Hardness
61 - 63 HRC

Isıl İşlem / Heat Treatment

Sementasyon / Case Hardened

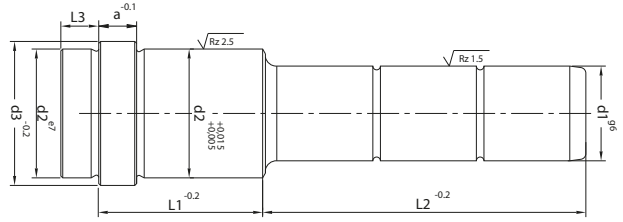
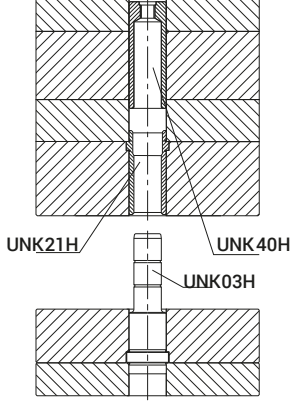

Sip. Kodu / Or. Code	d1	Sip. Kodu / Or. Code	d1	L1	L2	d2	d3	a	L3
UNK 03H-221735		03H-241735			35				
55	22	55	24	17	55	30	35	6	9
75		75			75				
UNK 03H-222235		03H-242235			35				
55		55			55				
75	22	75	24	22	75	30	35	6	9
95		95			95				
105		105			105				
130		130			130				
UNK 03H-222735		03H-242735			35				
45		45			45				
65		65			65				
85		85			85				
105	22	105	24	27	105	30	35	6	9
125		125			125				
165		165			165				
205		205			205				
245		245			245				

UNK 03

Kuyruklu Şapkalı Kademeli Kolon Tailed Guide Pillar

Malzeme / Material
1.7131 (16MnCr5)

Sertlik / Hardness
61 - 63 HRC

Isıl İşlem / Heat Treatment

Sementasyon / Case Hardened

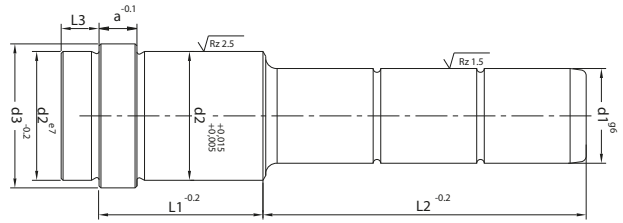
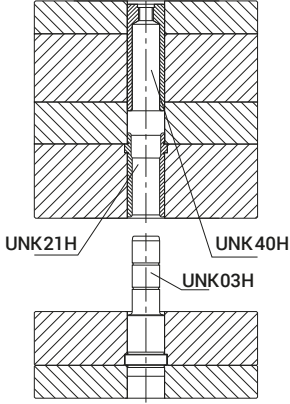

Sip. Kodu / Or. Code	d1	Sip. Kodu / Or. Code	d1	L1	L2	d2	d3	a	L3
UNK 03H-223635	22	03H-243635	24	36	35	30	35	6	9
55		55							
75		75							
95		95							
115		115							
135		135							
165		165							
205		205							
245		245							
285		285							
UNK 03H-224635	22	03H-244635	24	46	35	30	35	6	9
45		45							
65		65							
85		85							
105		105							
125		125							
165		165							
205		205							
UNK03H-225635	22	03H-245635	24	56	35	30	35	6	9
55		55							
75		75							
95		95							
115		115							
135		135							

UNK 03

Kuyruklu Şapkalı Kademeli Kolon Tailed Guide Pillar

Malzeme / Material
1.7131 (16MnCr5)

Sertlik / Hardness
61 - 63 HRC

Isıl İşlem / Heat Treatment

Sementasyon / Case Hardened

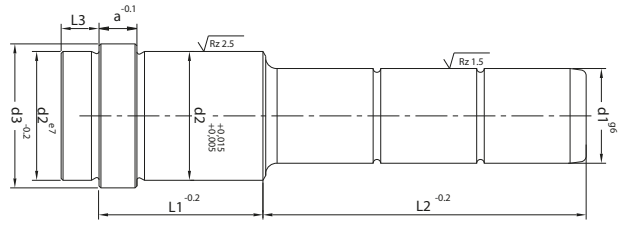
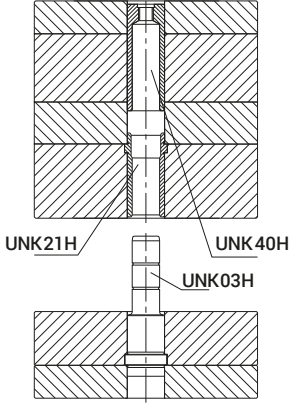

Sip. Kodu / Or. Code	d1	Sip. Kodu / Or. Code	d1	L1	L2	d2	d3	a	L3
UNK03H-2256165	22	03H-2456165	24	56	165	30	35	6	9
205		205			205				
UNK 03H-226635	22	03H-246635	24	66	35	30	35	6	9
55		55			55				
75		75			75				
95		95			95				
115		115			115				
135		135			135				
155	155	155							
UNK03H-227635	22	03H-247635	24	76	35	30	35	6	9
55		55			55				
75		75			75				
95		95			95				
115		115			115				
145	145	145							
UNK 03H-228655	22	03H-248655	24	86	55	30	35	6	9
75		75			75				
95		95			95				
125		125			125				
135	135	135							
UNK03H-229655	22	03H-249655	24	96	55	30	35	6	9
75		75			75				
95		95			95				
125		125			125				

UNK 03

Kuyruklu Şapkalı Kademeli Kolon Tailed Guide Pillar

Malzeme / Material
1.7131 (16MnCr5)

Sertlik / Hardness
61 - 63 HRC

Isıl İşlem / Heat Treatment

Sementasyon / Case Hardened

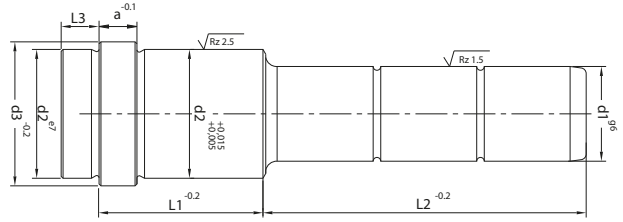
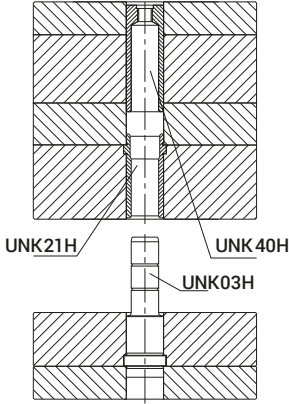

Sip. Kodu / Or. Code	d1	Sip. Kodu / Or. Code	d1	L1	L2	d2	d3	a	L3
UNK03H-2210655	22	03H-2410655	24	106	55	30	35	6	9
75		75							
95		95							
115		115							
UNK03H-2211675	22	03H-2411675	24	116	75	30	35	6	9
115		115							
155		155							
UNK03H-2213695	22	03H-2413695	24	136	95	30	35	6	9
135		135							
UNK 03H-302735	30	03H-322735	32	27	35	42	47	6	9
45		45							
65		65							
85		85							
105		105							
125		125							
145		145							
165		165							
185		185							
245		245							
285	285								

UNK 03

Kuyruklu Şapkalı Kademeli Kolon Tailed Guide Pillar

Malzeme / Material
1.7131 (16MnCr5)

Sertlik / Hardness
61 - 63 HRC

Isıl İşlem / Heat Treatment

Sementasyon / Case Hardened

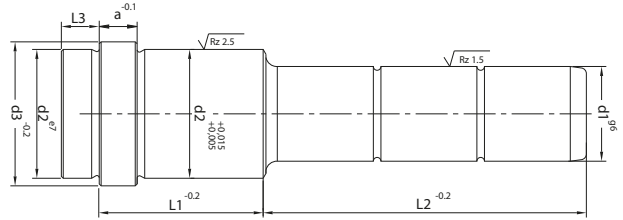
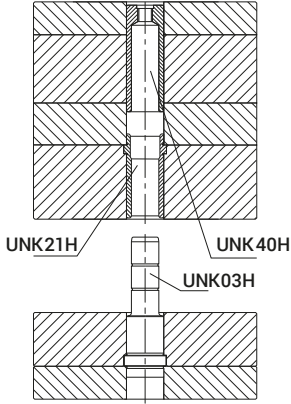

Sip. Kodu / Or. Code	d1	Sip. Kodu / Or. Code	d1	L1	L2	d2	d3	a	L3
UNK03H-303635	30	03H-323635	32	36	35	42	47	6	9
55		55							
75		75							
95		95							
115		115							
135		135							
155		155							
245		245							
285		285							
UNK03H-304645	30	03H-324645	32	46	45	42	47	6	9
65		65							
85		85							
105		105							
125		125							
145		145							
165		165							
245		245							
285		285							

UNK 03

Kuyruklu Şapkalı Kademeli Kolon Tailed Guide Pillar

Malzeme / Material
1.7131 (16MnCr5)

Sertlik / Hardness
61 - 63 HRC

Isıl İşlem / Heat Treatment

Sementasyon / Case Hardened

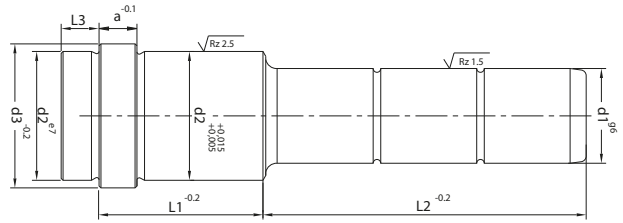
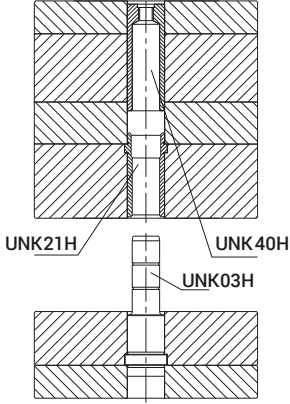

Sip. Kodu / Or. Code	d1	Sip. Kodu / Or. Code	d1	L1	L2	d2	d3	a	L3
UNK 03H-305645	30	03H-325645	32	56	45	42	47	6	9
55		55							
75		75							
95		95							
115		115							
135		135							
155		155							
175		175							
245		245							
295		295							
UNK 03H-306645	30	03H-326645	32	66	45	42	47	6	9
55		55							
75		75							
95		95							
115		115							
135		135							
155		155							
175		175							
245		245							
295		295							
UNK 03H-307655	30	03H-327655	32	76	55	42	47	6	9
75		75							
95		95							
115		115							
135		135							
225		225							

UNK 03

Kuyruklu Şapkalı Kademeli Kolon Tailed Guide Pillar

Malzeme / Material
1.7131 (16MnCr5)

Sertlik / Hardness
61 - 63 HRC

Isıl İşlem / Heat Treatment

Sementasyon / Case Hardened

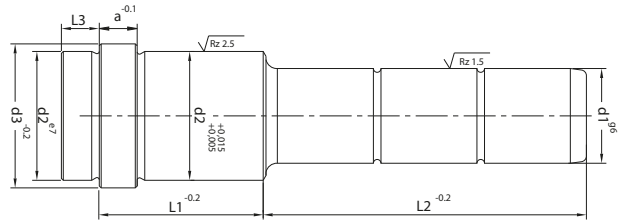
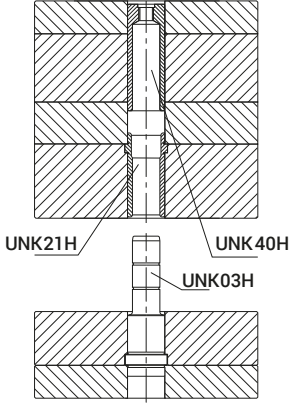

Sip. Kodu / Or. Code	d1	Sip. Kodu / Or. Code	d1	L1	L2	d2	d3	a	L3
UNK 03H-308655		03H-328655			55				
75	30	75	32	86	75	42	47	6	9
95		95							
115		115							
135		135							
155		155							
225		225							
UNK 03H-309655		03H-329655			55				
75	30	75	32	96	75	42	47	6	9
95		95							
115		115							
135		135							
155		155							
205		205							
UNK03H-3010675		03H-3210675			75				
95	30	95	32	106	95	42	47	6	9
115		115							
125		125							
145		145							
165		165							
UNK03H-3011675		03H-3211675			75				
95	30	95	32	116	95	42	47	6	9
115		115							
135		135							
155		155							

UNK 03

Kuyruklu Şapkalı Kademeli Kolon Tailed Guide Pillar

Malzeme / Material
1.7131 (16MnCr5)

Sertlik / Hardness
61 - 63 HRC

Isıl İşlem / Heat Treatment

Sementasyon / Case Hardened

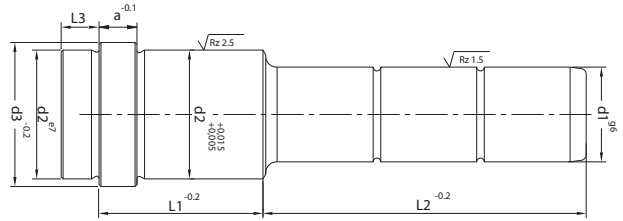
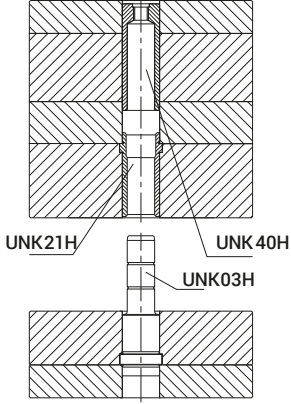

Sip. Kodu / Or. Code	d1	Sip. Kodu / Or. Code	d1	L1	L2	d2	d3	a	L3
UNK03H-3013695	30	03H-3213695	32	136	95	42	47	6	9
115		115			115				
135		135			135				
155		155			155				
UNK03H-30156115	30	03H-32156115	32	156	115	42	47	6	9
155		155			155				
UNK03H-30196155	30	03H-32196155	32	196	155	42	47	6	9
195		195			195				
UNK 03H-404695	40	03H-424695	42	46	95	54	60	10	12
165		165			165				
UNK 03H-405675	40	03H-425675	42	56	75	54	60	10	12
115		115			115				
155		155			155				
195		195			195				
UNK 03H-406675	40	03H-426675	42	66	75	54	60	10	12
135		135			135				
UNK 03H-407675	40	03H-427675	42	76	75	54	60	10	12
115		115			115				
175		175			175				
UNK 03H-408675	40	03H-428675	42	86	75	54	60	10	12
135		135			135				
UNK 03H-409675	40	03H-429675	42	96	75	54	60	10	12
115		115			115				
155		155			155				

UNK 03

Kuyruklu Şapkalı Kademeli Kolon Tailed Guide Pillar

Malzeme / Material
1.7131 (16MnCr5)

Sertlik / Hardness
61 - 63 HRC

Isıl İşlem / Heat Treatment

Sementasyon / Case Hardened

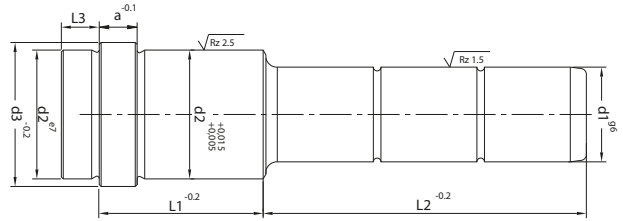
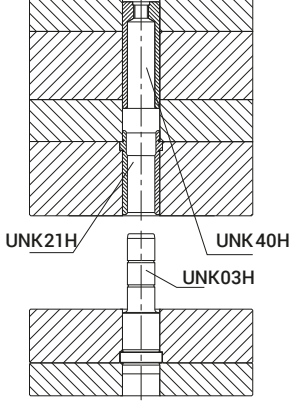

Sip. Kodu / Or. Code	d1	Sip. Kodu / Or. Code	d1	L1	L2	d2	d3	a	L3
UNK 03H-4011695	40	03H-4211695	42	116	95	54	60	10	12
135		135							
195		195							
UNK 03H-4013695	40	03H-4213695	42	136	95	54	60	10	12
135		135							
215		215							
UNK 03H-40156115	40	03H-42156115	42	156	115	54	60	10	12
155		155							
215		215							
UNK 03H-40196155	40	03H-42196155	42	196	155	54	60	10	12
195		195							
235		235							
UNK 03H-40246165	40	03H-42246165	42	246	165	54	60	10	12
245		245							

UNK 21H

**Kuyruklu
Şapkalı Burç**
Tailed Guide Bush

Malzeme / Material
1.7131 (16MnCr5)

Sertlik / Hardness
61 - 63 HRC

Isıl İşlem / Heat Treatment

Sementasyon / Case Hardened

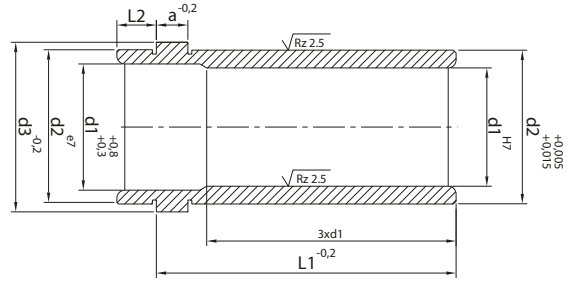
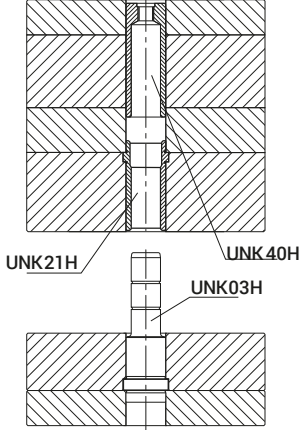

Sip. Kodu / Or. Code	d1	Sip. Kodu / Or. Code	d1	L1	d2	d3	a	L2
UNK21H-1417	14	21H-1517	15	17	20	25	6	9
22		22						
27		27						
36		36						
46		46						
56		56						
66		66						
76		76						
86		86						
96		96						
116	116							
UNK 21H-1817	18	21H-2017	20	17	26	31	6	9
22		22						
27		27						
36		36						
46		46						
56		56						
66		66						
76		76						
86		86						
96		96						
106	106							
116	116							
136	136							

UNK 21H

**Kuyruklu
Şapkalı Burç**
Tailed Guide Bush

Malzeme / Material
1.7131 (16MnCr5)

Sertlik / Hardness
61 - 63 HRC

Isıl İşlem / Heat Treatment

Sementasyon / Case Hardened

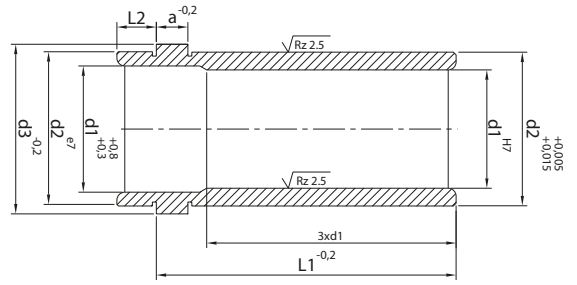
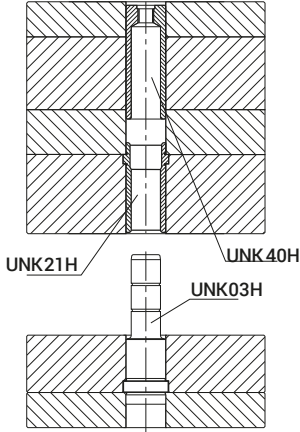

Sip. Kodu / Or. Code	d1	Sip. Kodu / Or. Code	d1	L1	d2	d3	a	L2
UNK 21H-2217	22	21H-2417	24	17	30	35	6	9
22		22						
27		27						
36		36						
46		46						
56		56						
66		66						
76		76						
86		86						
96		96						
106		106						
116		116						
136		136						
156		156						

UNK 21H

**Kuyruklu
Şapkalı Burç**
Tailed Guide Bush

Malzeme / Material
1.7131 (16MnCr5)
Sertlik / Hardness
61 - 63 HRC
Isıl İşlem / Heat Treatment
Sementasyon / Case Hardened

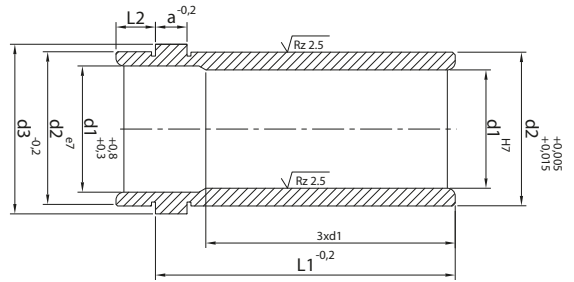
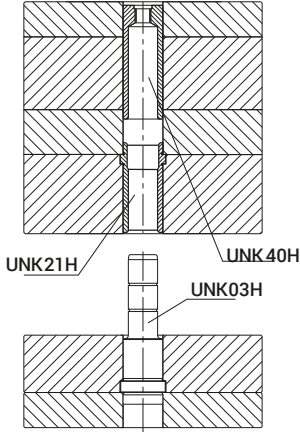

Sip. Kodu / Or. Code	d1	Sip. Kodu / Or. Code	d1	L1	d2	d3	a	L2
UNK 21H-3027	30	21H-3227	32	27	42	47	6	9
36		36						
46		46						
56		56						
66		66						
76		76						
86		86						
96		96						
106		106						
116		116						
126		126						
136		136						
156		156						
196		196						
UNK 21H-4046	40	21H-4246	42	46	54	60	10	12
56		56						
66		66						
76		76						
86		86						
96		96						
116		116						
136		136						
156	156							
196	196							
246	246							

UNK 20

Şapkalı Burç

Guide Bush

Malzeme / Material
1.7131 (16MnCr5)

Sertlik / Hardness
61 - 63 HRC

Isıl İşlem / Heat Treatment

Sementasyon / Case Hardened

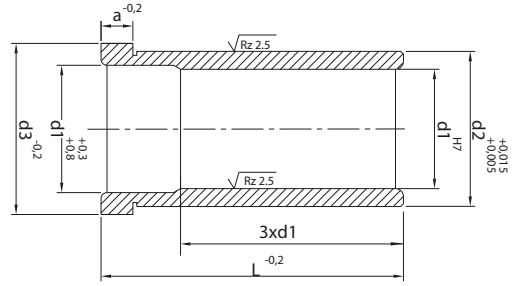
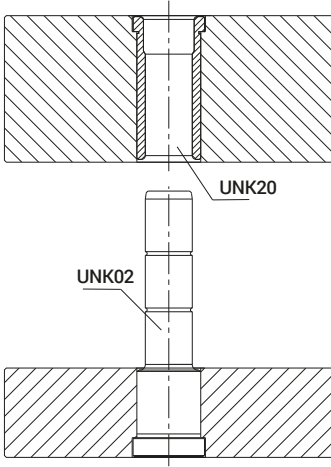

Sipariş Kodu / Order Code	d1	L	d2	d3	a
UNK 20-3036	30	36	39	43	10
46		46			
56		56			
66		66			
76		76			
86		86			
96		96			
106		106			
116		116			
UNK 20-4046		40			
56	56				
66	66				
76	76				
86	86				
96	96				
106	106				
116	116				
126	126				
136	136				
146	146				

UNK 40H

Tespit Burcu

Centring Sleeves

Malzeme / Material
1.7131 (16MnCr5)

Sertlik / Hardness
61 - 63 HRC

Isıl İşlem / Heat Treatment

Sementasyon / Case Hardened

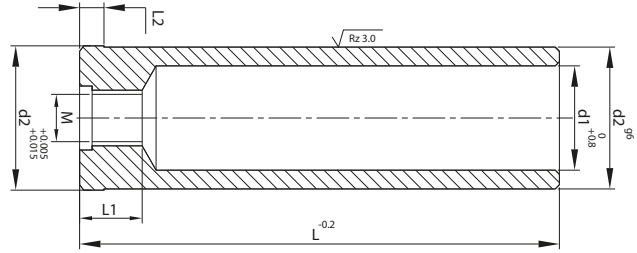
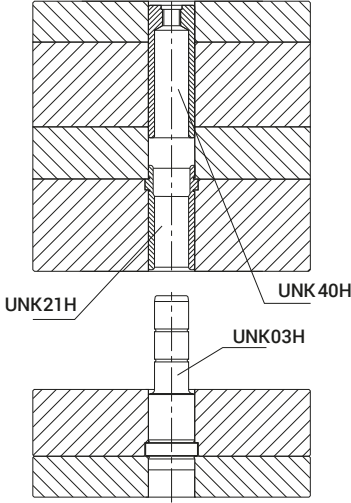

Sipariş Kodu / Order Code	d1	L	d2	M	L1	L2
UNK 40H-2030	16	30	20	12	13	4
40		40				
60		60				
80		80				
100		100				
120		120				
140		140				
UNK 40H-2630	21	30	26	12	13	4
40		40				
60		60				
80		80				
100		100				
120		120				
140		140				
160	160					
UNK 40H-3040	25	40	30	12	13	4
60		60				
80		80				
100		100				
120		120				
140		140				
160		160				
180	180					
200	200					

UNK 40H

Tespit Burcu

Centring Slaves

Malzeme / Material
1.7131 (16MnCr5)

Sertlik / Hardness

Isıl İşlem / Heat Treatment

Sementasyon / Case Hardened

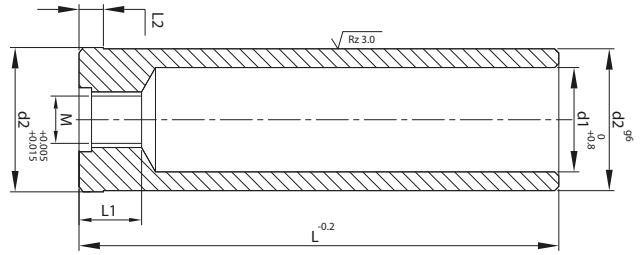
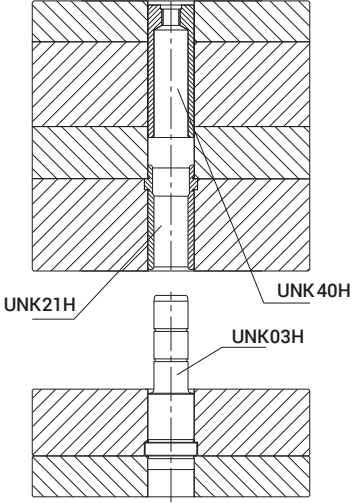

Sipariş Kodu / Order Code	d1	L	d2	M	L1	L2
UNK 40H-4240	33	40	42	12	13	4
60						
80						
100						
120						
140						
160						
180						
200						
220						
UNK 40H-5460	43	60	54	12	16	4
80						
120						
160						
200						
240						

UNK 50 Konik Kitleme Locating Unit

Malzeme / Material
1.7131 (16MnCr5)

Sertlik / Hardness
61 - 63 HRC

Isıl İşlem / Heat Treatment
Sementasyon / Case Hardened

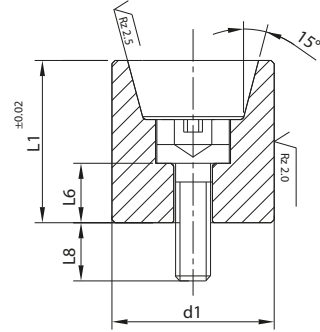
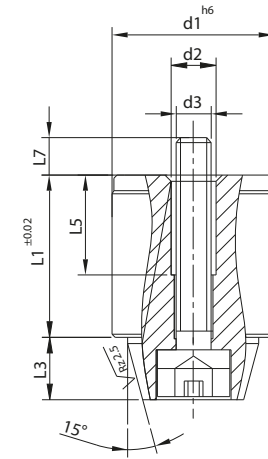
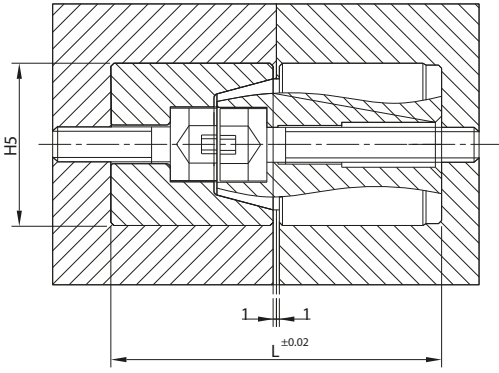

Sip. Kodu / Or. Code	d1	L	L1	L3	L5	L6	L7	L8	d2	d3
UNK 50-12	12	34	16	4.5	9.5	7.0	8	7.5	M4	M3
50-14	14	34	16	6	12.4	6.0	7.5	8	M5	M4
50-16	16	34	16	6	12.4	5.8	7.5	8	M5	M4
50-20	20	54	26	9	19.7	10.6	12	9.5	M8	M6
50-25	25	54	26	10	19.7	9.2	11	11	M8	M6
50-30	30	72	35	14	25.0	12.2	15	13	M10	M8
50-42	42	92	45	18	27.0	16.8	16	13	M10	M8

UNK 22

**Ortadan
Flanşlı Burç**
Middle Flanged Bush

Malzeme / Material
1.7131 (16MnCr5)
Sertlik / Hardness
61 - 63 HRC
Isıl İşlem / Heat Treatment
Sementasyon / Case Hardened

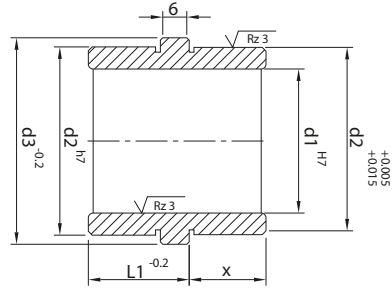
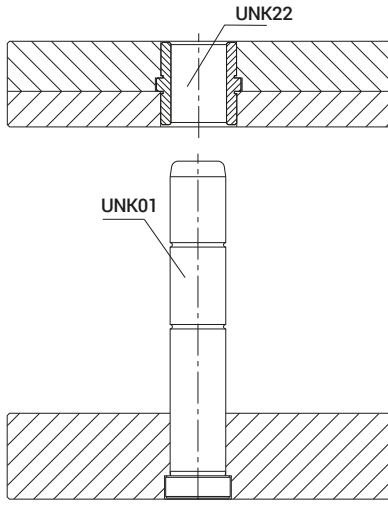

Sipariş Kodu / Order Code	d1	L1	d2	d3	x
UNK 22-1416	14	16	20	25	12
22-1616	16	16	24	28	12
22-1816	18	16	26	31	12
22-2016	20	16	28	32	12
22-2521	25	21	34	38	16
22-3021	30	21	39	43	16

UNK 00

Ortadan Şapkalı Kolon Guide Pillar

Malzeme / Material
1.1213 (CF53)

Sertlik / Hardness
61 - 63 HRC

Isıl İşlem / Heat Treatment

İndüksiyon Sertleştirme
Induction Hardening

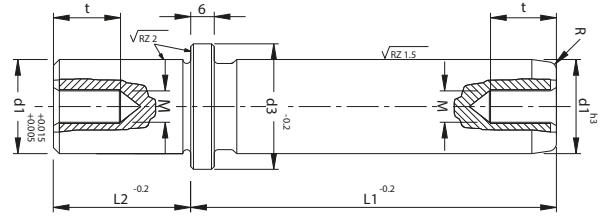
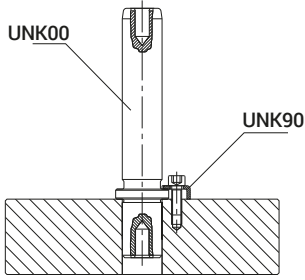
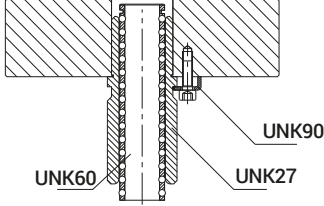

Sipariş Kodu / Order Code	d1	L1	L2	d3	t	R	M
UNK00-1610020		100					
11220		112					
12520		125					
14020	16	140	20	22	20	3	6
16020		160					
18020		180					
20020		200					
UNK00-2010023		100					
11223		112					
12523		125					
14023	20	140	23	25	20	3	8
16023		160					
18023		180					
20023		200					
UNK00-2510030		100					
11230		112					
12530		125					
14030		140					
16030	25	160	30	32	20	5	8
18030		180					
20030		200					
22430		224					
25030		250					

UNK 00

**Ortadan
Şapkalı Kolon**
Guide Pillar

Malzeme / Material
1.1213 (CF53)
Sertlik / Hardness
61 - 63 HRC
Isıl İşlem / Heat Treatment
İndüksiyon Sertleştirme
Induction Hardening

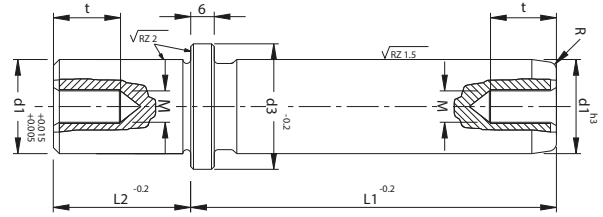
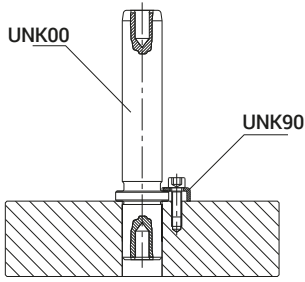
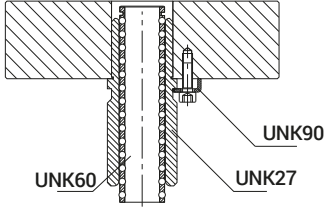

Sipariş Kodu / Order Code	d1	L1	L2	d3	t	R	M
UNK00-3011237	30	112	37	40	20	5	8
12537		125					
14037		140					
16037		160					
18037		180					
20037		200					
22437		224					
25037		250					
28037		280					
31537		315					
UNK00-3211237		32					
12537	125						
14037	140						
16037	160						
18037	180						
20037	200						
22437	224						
25037	250						
28037	280						
31537	315						

UNK 00

Ortadan Şapkalı Kolon Guide Pillar

Malzeme / Material
1.1213 (CF53)

Sertlik / Hardness
61 - 63 HRC

Isıl İşlem / Heat Treatment

İndüksiyon Sertleştirme
Induction Hardening

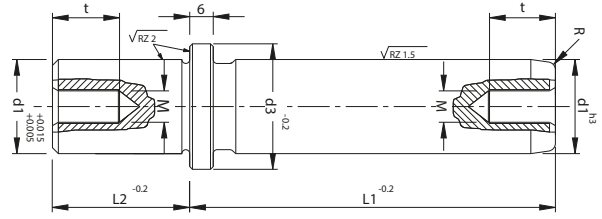
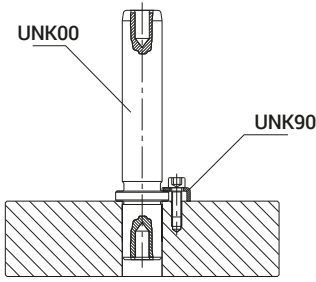
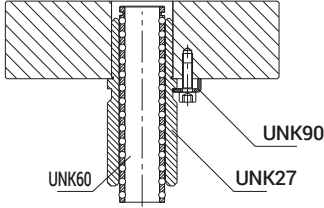

Sipariş Kodu / Order Code	d1	L1	L2	d3	t	R	M
UNK00-4012537	40	125	37	50	20	5	8
14037		140					
16037		160					
18037		180					
20037		200					
22437		224					
25037		250					
28037		280					
31537		315					
35537		355					
UNK00-5014047	50	140	47	63	20	5	8
16047		160					
18047		180					
20047		200					
22447		224					
25047		250					
28047		280					
31547		315					
35547	355						
40047	400						

UNK 00

Ortadan Şapkalı Kolon Guide Pillar

Malzeme / Material
1.1213 (CF53)

Sertlik / Hardness
61 - 63 HRC

Isıl İşlem / Heat Treatment

İndüksiyon Sertleştirme
Induction Hardening

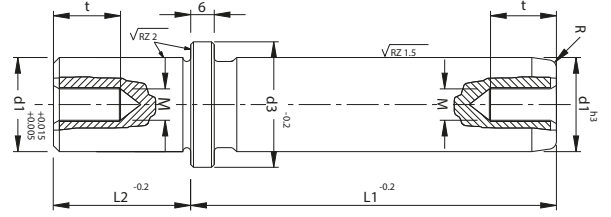
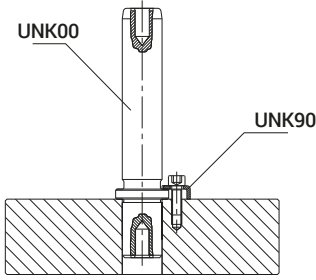
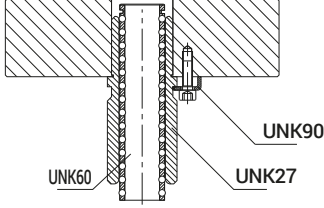

Sipariş Kodu / Order Code	d1	L1	L2	d3	t	R	M
UNK 00-6316047		160					
18047		180					
20047		200					
22447		224					
25047	63	250	47	80	20	5	8
28047		280					
31547		315					
35547		355					
40047		400					

• Ø80 siparişe göre üretilir. / Ø80 available on customer request

UNK 09

Düz Kolon Guide Pillar

Malzeme / Material
1.1213 (CF53)

Sertlik / Hardness
61 - 63 HRC

Isıl İşlem / Heat Treatment

İndüksiyon Sertleştirme
Induction Hardening

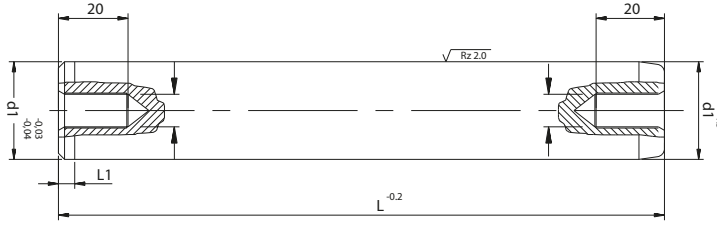

Sipariş Kodu / Order Code	d1	L	L1	M
UNK 09-1280		80		
100		100		
120	12	120	3	5
140		140		
160		160		
UNK 09-1880		80		
100		100		
120	18	120	3	5
140		140		
160		160		
180		180		
UNK09-20100		100		
112		112		
125		125		
140	20	140	4	8
160		160		
180		180		
200		200		
224		224		

UNK 09

Düz Kolon Guide Pillar

Malzeme / Material
1.1213 (CF53)

Sertlik / Hardness
61 - 63 HRC

Isıl İşlem / Heat Treatment

İndüksiyon Sertleştirme
Induction Hardening

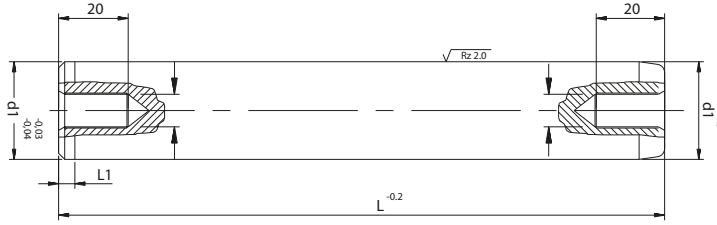

Sipariş Kodu / Order Code	d1	L	L1	M
UNK 09-24100	24	100	4	8
120		120		
140		140		
160		160		
180		180		
200		200		
UNK 09-25112	25	112	4	8
125		125		
140		140		
160		160		
180		180		
200		200		
224		224		
250	250			
280	280			
UNK 09-30140	30	140	4	8
160		160		
180		180		
200		200		
224		224		
250		250		
280		280		
315	315			

UNK 09

Düz Kolon Guide Pillar

Malzeme / Material
1.1213 (CF53)

Sertlik / Hardness
61 - 63 HRC

Isıl İşlem / Heat Treatment

İndüksiyon Sertleştirme
Induction Hardening

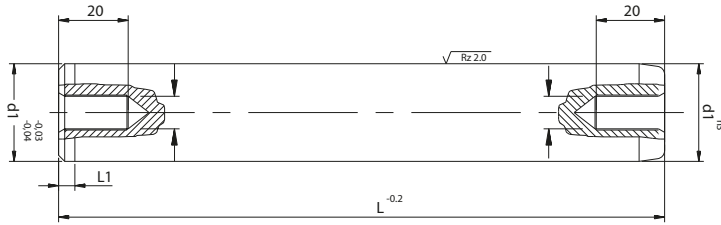

Sipariş Kodu / Order Code	d1	L	L1	M
UNK 09-40160	40	160	4	8
180		180		
200		200		
224		224		
250		250		
280		280		
315		315		
355		355		
400		400		
UNK 09-50180		50		
200	200			
224	224			
250	250			
280	280			
315	315			
355	355			
400	400			
500	500			
UNK 09-63280	63		280	5
315		315		
355		355		
400		400		

• Ø63 siparişe göre üretilir. / Ø63 available on customer request

UNK 23

**Ortadan
Şapkalı Burç**
Guide Bush

Malzeme / Material
1.7131 (16MnCr5)
Sertlik / Hardness
61 - 63 HRC
Isıl İşlem / Heat Treatment
Sementasyon / Case Hardened

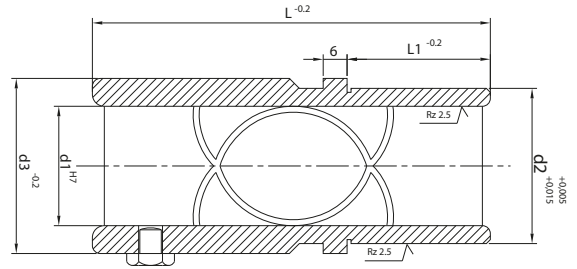
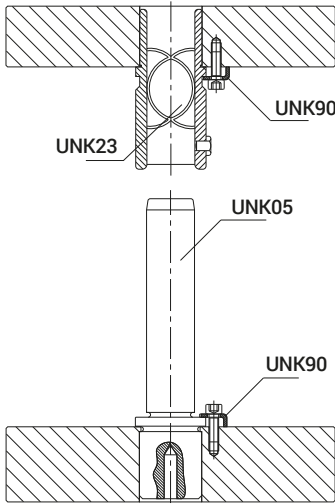

Sipariş Kodu / Order Code	d1	L	L1	d2	d3
UNK 23-207026	20	70	26	28	34
7036		70	36		
UNK 23-258026	25	80	26	34	39
8036		80	36		
UNK 23-309036	30	90	36	39	44
9046		90	46		
UNK23-4010036	40	100	36	50	54
10836		108	36	58	65
10046		100	46	50	54
UNK 23-5012046	50	120	46	60	64
12056		120	56	60	64
12756		127	56	70	75
UNK 23-6313056	63	130	56	85	95
15056		150	56		

UNK 4-20

**Düz
Tespit Pimi**
Detection Pin

Malzeme / Material
1.7131 (16MnCr5)
Sertlik / Hardness
61 - 63 HRC
Isıl İşlem / Heat Treatment
Sementasyon / Case Hardened
Standart : h6 toleranslı, m6 toleranslı

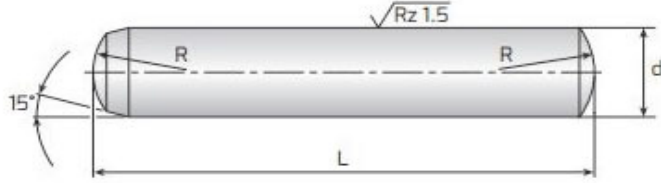

Sipariş Kodu / Order Code		d X L		L																		
DTP	D	10	15	20	25	30	35	40	45	50	55	60	70	80	90	100	120	140	150	160		
UNK	4	•	•	•	•	•	•	•	•	•	•	•	•	•								
	5	•	•	•	•	•	•	•	•	•	•	•	•	•								
	6	•	•	•	•	•	•	•	•	•	•	•	•	•	•	•	•					
	8	•	•	•	•	•	•	•	•	•	•	•	•	•	•	•	•	•				
	10	•	•	•	•	•	•	•	•	•	•	•	•	•	•	•	•	•	•	•	•	•
	12			•	•	•	•	•	•	•	•	•	•	•	•	•	•	•	•	•	•	•
	14					•	•	•	•	•	•	•	•	•	•	•	•	•	•	•	•	•
	16						•	•	•	•	•	•	•	•	•	•	•	•	•	•	•	•
	20							•	•	•	•	•	•	•	•	•	•	•	•	•	•	•

UNK 5-20

**Çektirmeli
Tespit Pimi**
Puller Pins

Malzeme / Material
1.7131 (16MnCr5)

Sertlik / Hardness
61 - 63 HRC

Isıl İşlem / Heat Treatment

Sementasyon / Case Hardened

Standart : h6 toleranslı, m6 toleranslı

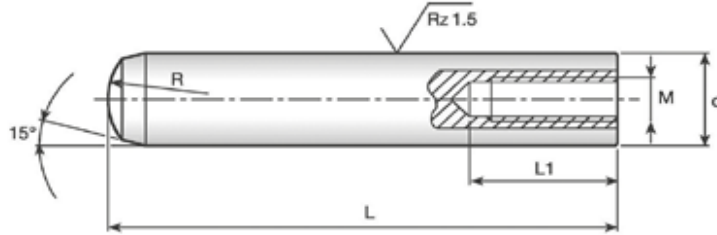

Sipariş Kodu /Order Code		d X L		L																	
ÇTP	D	10	15	20	25	30	35	40	45	50	55	60	70	80	90	100	120	140	150	160	
UNK	5			•	•	•	•	•	•	•	•	•	•	•							
	6			•	•	•	•	•	•	•	•	•	•	•	•	•					
	8			•	•	•	•	•	•	•	•	•	•	•	•	•	•				
	10			•	•	•	•	•	•	•	•	•	•	•	•	•	•	•	•	•	•
	12			•	•	•	•	•	•	•	•	•	•	•	•	•	•	•	•	•	•
	14					•	•	•	•	•	•	•	•	•	•	•	•	•	•	•	•
	16					•	•	•	•	•	•	•	•	•	•	•	•	•	•	•	•
	20					•	•	•	•	•	•	•	•	•	•	•	•	•	•	•	•

UNK 24

Üstten Şapkalı Burç
Guide Bush

Malzeme / Material
1.7131 (16MnCr5)
Sertlik / Hardness
61 - 63 HRC
Isıl İşlem / Heat Treatment
Sementasyon / Case Hardened

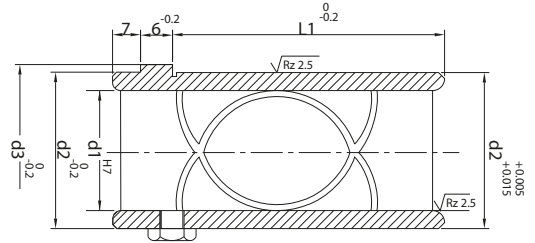
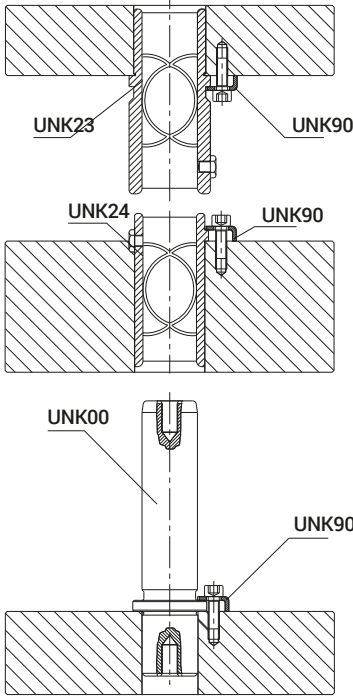

Sipariş Kodu / Order Code	d1	d2	L1	d3
UNK 24-202826	20	28	26	34
UNK 24-253426	25	34	26	39
3436			36	
UNK 24-303926	30	39	26	44
3936			36	
UNK 24-405036	40	50	36	54
5046		50	46	54
5846		58	46	65
UNK 24-506046	50	60	46	64
6056		60	56	64
7046		70	46	75
UNK 24-638546	63	85	46	95
8556			56	

UNK ER16

Kılavuz Çekme Aparatı Tapping Apparatus

Malzeme / Material
1.7131 (16MnCr5)

Sertlik / Hardness
61 - 63 HRC

Isıl İşlem / Heat Treatment

Sementasyon / Case Hardened

Standart : h6 toleranslı, m6 toleranslı

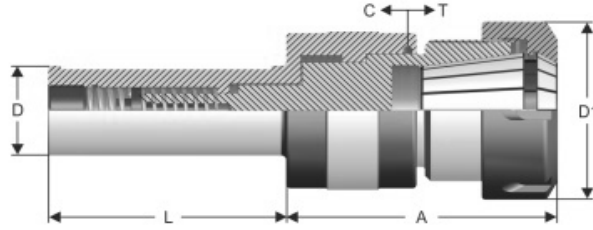

Sipariş Kodu /Order Code	KAPASİTE	D	L	A	D1	C	T
UNK ER-16 426 Kılavuz Çekme Aparatı	2...10 mm	20	20	45	32	8	3
UNK ER-32 470 Kılavuz Çekme Aparatı	2...20 mm	32	80	88	50	9	4
UNK ER-40 472 Kılavuz Çekme Aparatı	2...26 mm	32	80	96	53	9	4

Torna ve işleme merkezin de kullanıma uygun
Suitable for use in lathe and machining centers

